



MN51/08

DARWIN

17 December 2008

Mining Act

NOTICE OF LAND CEASING TO BE AN EXPLORATION LICENCE AREA

Title Type and Number: Exploration Licence 23132
 Area Ceased on: 17 July 2008
 Area: 99 Blocks, 315.87 sq kms
 Locality: MOUNT FAREWELL
 Name of Holder/s: 100% PALACE RESOURCES LIMITED [ACN. 106 240 475]

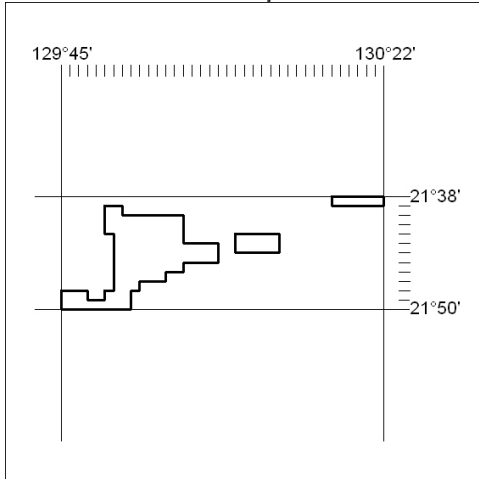

661/08

Mining Act

NOTICE OF LAND CEASING TO BE AN EXPLORATION LICENCE AREA

Title Type and Number: Exploration Licence 24115
 Area Ceased on: 13 October 2008
 Area: 20 Blocks, 65.32 sq kms
 Locality: PARADISE BORE
 Name of Holder/s: 100% MARENCO MINING LTD [ACN. 099 496 474]

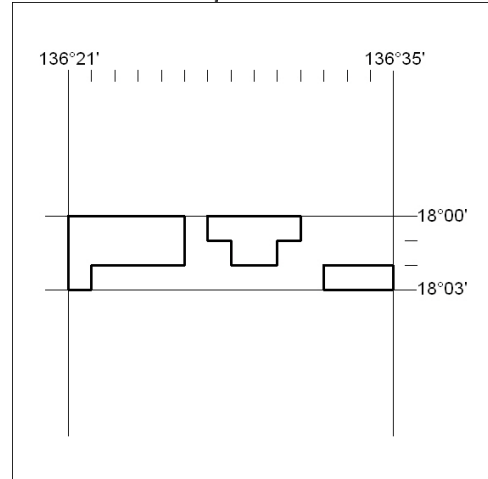

663/08

Mining Act

NOTICE OF LAND CEASING TO BE AN EXPLORATION LICENCE AREA

Title Type and Number: Exploration Licence 23136
 Area Ceased on: 17 July 2008
 Area: 11 Blocks, 35.14 sq kms
 Locality: MOUNT FAREWELL
 Name of Holder/s: 100% PALACE RESOURCES LIMITED [ACN. 106 240 475]

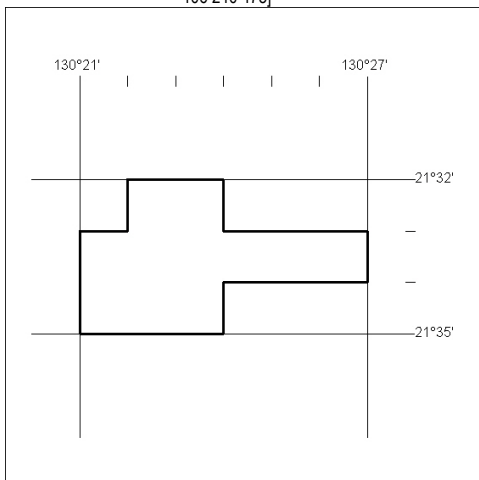

662/08

Mining Act

NOTICE OF LAND CEASING TO BE AN EXPLORATION LICENCE AREA

Title Type and Number: Exploration Licence 24646
 Area Ceased on: 16 December 2008
 Area: 101 Blocks, 316.60 sq kms
 Locality: HALE
 Name of Holder/s: 100% MINEX (AUST) PTY LTD [ACN. 091 546 708]

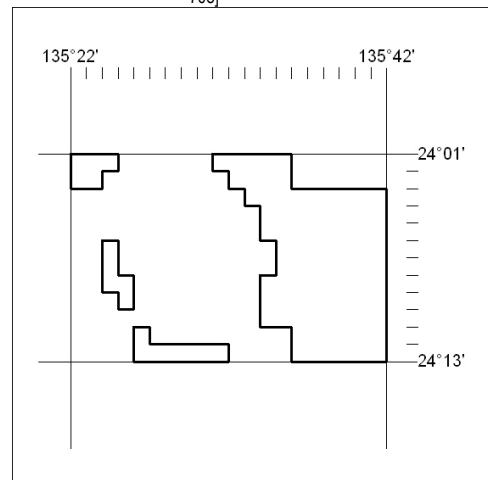

664/08



MN51/08

DARWIN

17 December 2008

Mining Act

NOTICE OF LAND CEASING TO BE AN EXPLORATION LICENCE AREA

Title Type and Number: Exploration Licence 24693
 Area Ceased on: 13 December 2008
 Area: 244 Blocks, 770.44 sq kms
 Locality: ADAM
 Name of Holder/s: 100% URAMET MINERALS LIMITED [ACN. 124 251 396]

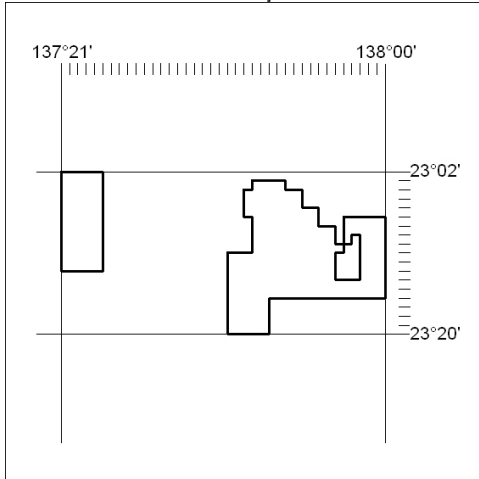

665/08

Mining Act

NOTICE OF LAND CEASING TO BE AN EXPLORATION LICENCE AREA

Title Type and Number: Exploration Licence 25546
 Area Ceased on: 15 December 2008
 Area: 70 Blocks, 230.55 sq kms
 Locality: PIGEON
 Name of Holder/s: 100% KETTLE ROSE PTY LTD [ACN. 119 016 330]

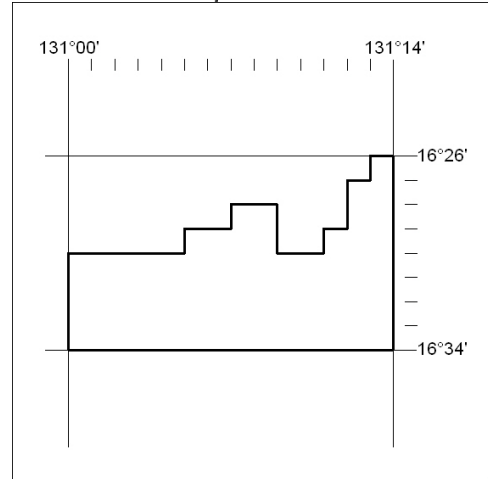

667/08

Mining Act

NOTICE OF LAND CEASING TO BE AN EXPLORATION LICENCE AREA

Title Type and Number: Exploration Licence 25210
 Area Ceased on: 13 November 2008
 Area: 60 Blocks, 174.59 sq kms
 Locality: TANAMI
 Name of Holder/s: 100% OKLO URANIUM LIMITED [ACN. 121 582 607]

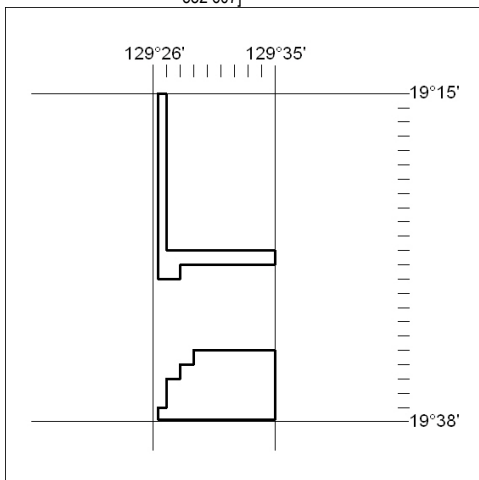

666/08

Mining Act

NOTICE OF GRANT OF AN EXPLORATION LICENCE AREA

Title Type and Number: Exploration Licence 26722
 Granted: 15 December 2008, for a period of 6 Years
 Area: 475 Blocks, 1571.00 sq kms
 Locality: DELAMERE
 Name of Holder/s: 100% SCRIVEN Neil Henry

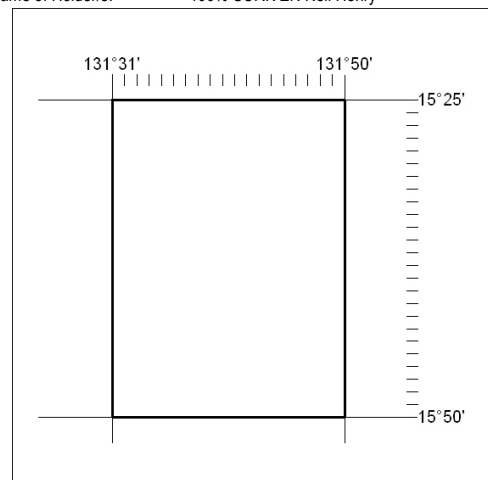

Area granted depicted above. Excluding therefrom all land that is subject of a mining tenement, or an application for a mining tenement made before the application for the grant of this licence, and excluding all land the subject of a reservation from occupation under the *Mining Act* and all land vested in the Commonwealth of Australia.

668/08



MN51/08

DARWIN

17 December 2008

Mining Act

NOTICE OF GRANT OF AN EXPLORATION LICENCE

Title Type and Number: Exploration Licence 26738
Granted: 10 December 2008, for a period of 6 Years
Area: 138 Blocks, 377.60 sq kms
Locality: ROPER
Name of Holder/s: 100% RED METAL LIMITED [ACN. 103 367 684]

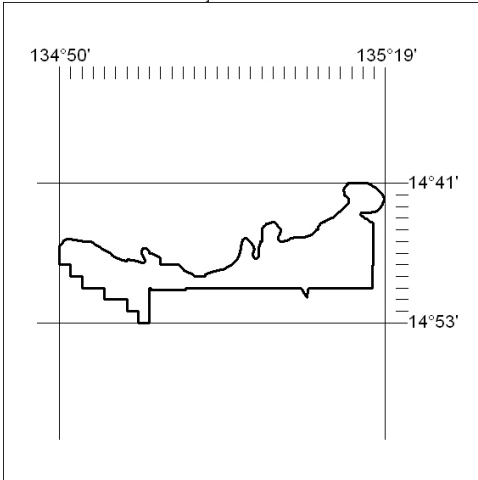

Area granted depicted above. Excluding therefrom all land that is subject of a mining tenement, or an application for a mining tenement made before the application for the grant of this licence, and excluding all land the subject of a reservation from occupation under the *Mining Act* and all land vested in the Commonwealth of Australia.

669/08

Mining Act

NOTICE OF GRANT OF AN EXPLORATION LICENCE

Title Type and Number: Exploration Licence 26924
Granted: 08 December 2008, for a period of 6 Years
Area: 18 Blocks, 59.86 sq kms
Locality: EVA VALLEY
Name of Holder/s: 100% SOFTWOOD PLANTATIONS PTY LTD [ACN. 050 120 315]

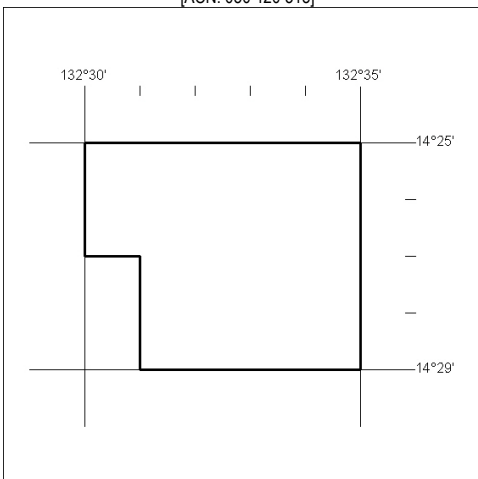

Area granted depicted above. Excluding therefrom all land that is subject of a mining tenement, or an application for a mining tenement made before the application for the grant of this licence, and excluding all land the subject of a reservation from occupation under the *Mining Act* and all land vested in the Commonwealth of Australia.

670/08

CANCELLATION

Notice Number 640/08 appearing in MN50/08 on 10 December 2008 for Exploration Licence 24646, is hereby cancelled.

671/08