

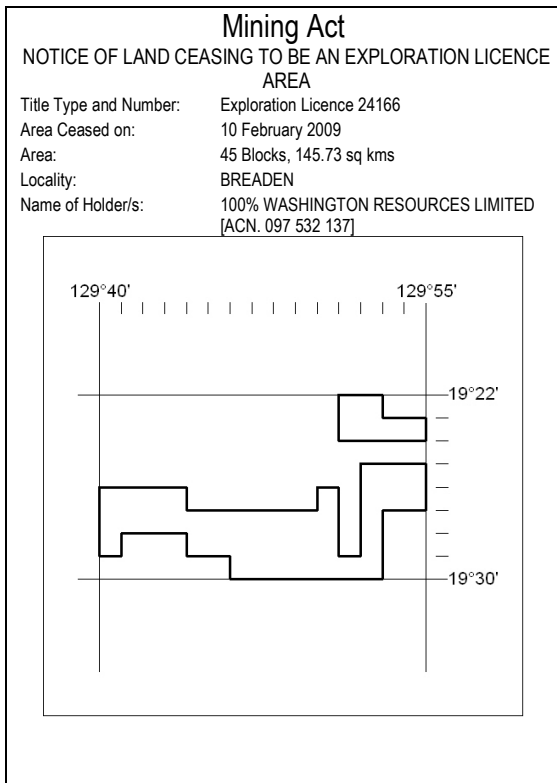

MN06/09

DARWIN

11 February 2009



43/09

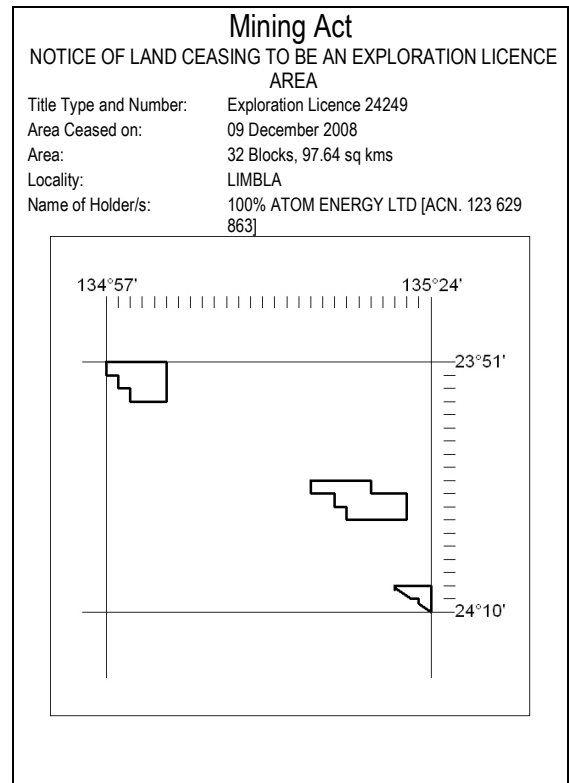

45/09

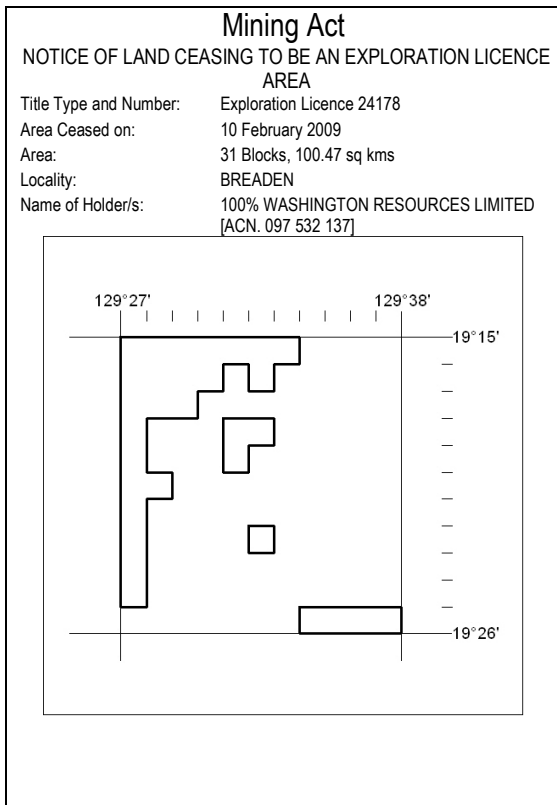

44/09

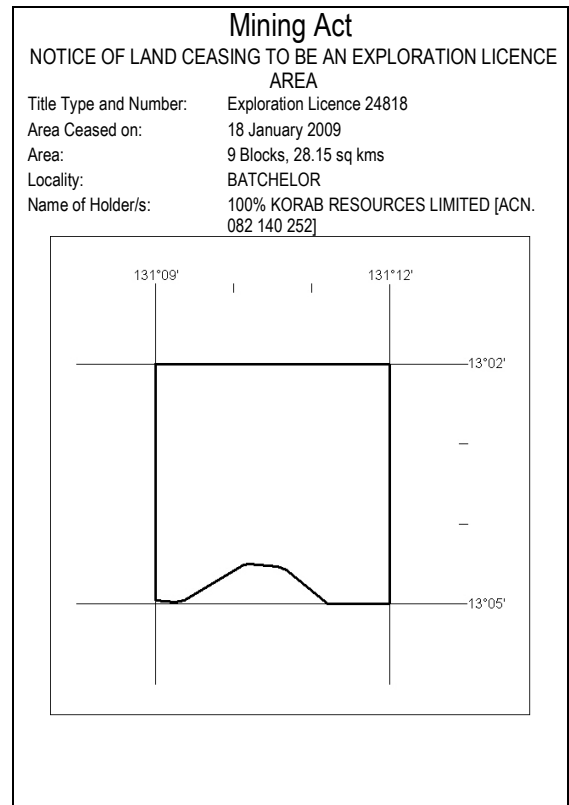

46/09



MN06/09

DARWIN

11 February 2009

Mining Act

NOTICE OF LAND CEASING TO BE AN EXPLORATION LICENCE AREA

Title Type and Number: Exploration Licence 25239
 Area Ceased on: 06 February 2009
 Area: 90 Blocks, 199.90 sq kms
 Locality: KOOLPINYAH
 Name of Holder/s: 100% TERRITORY URANIUM COMPANY LTD* [ACN. 115 770 226]

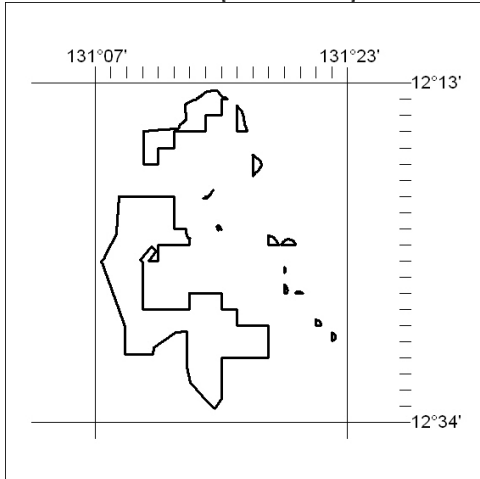

47/09

Mining Act

NOTICE OF LAND CEASING TO BE AN EXPLORATION LICENCE AREA

Title Type and Number: Exploration Licence 25373
 Area Ceased on: 09 February 2009
 Area: 104 Blocks, 322.20 sq kms
 Locality: LIMBLA
 Name of Holder/s: 100% RED DESERT MINERALS PTY LTD [ACN. 122301839]

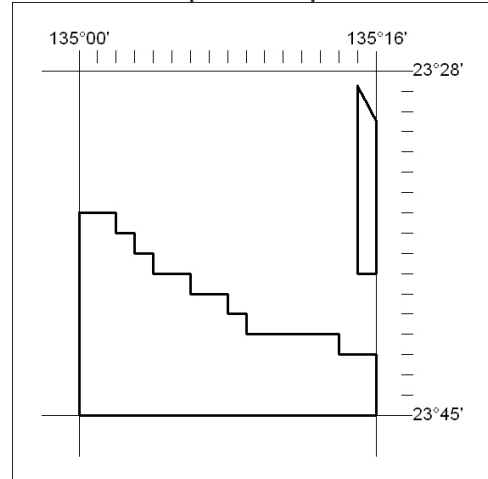

49/09

Mining Act

NOTICE OF LAND CEASING TO BE AN EXPLORATION LICENCE AREA

Title Type and Number: Exploration Licence 25294
 Area Ceased on: 06 February 2009
 Area: 1 Block, 3.12 sq kms
 Locality: PINE CREEK
 Name of Holder/s: 100% TERRITORY URANIUM COMPANY LTD* [ACN. 115 770 226]

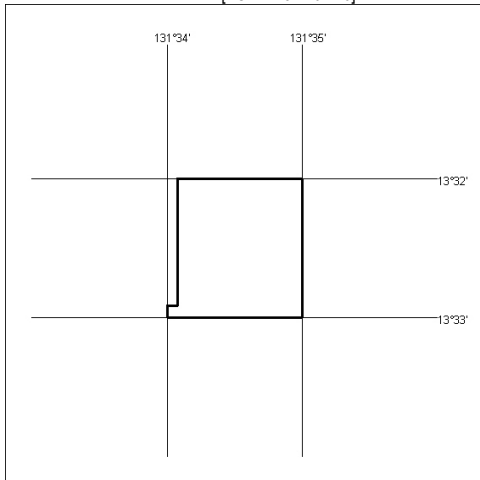

48/09

Mining Act

NOTICE OF LAND CEASING TO BE AN EXPLORATION LICENCE AREA

Title Type and Number: Exploration Licence 25382
 Area Ceased on: 05 February 2009
 Area: 38 Blocks, 120.75 sq kms
 Locality: VAUGHAN
 Name of Holder/s: 100% BRALICH HOLDINGS PTY LTD [ACN. 060 990 632]

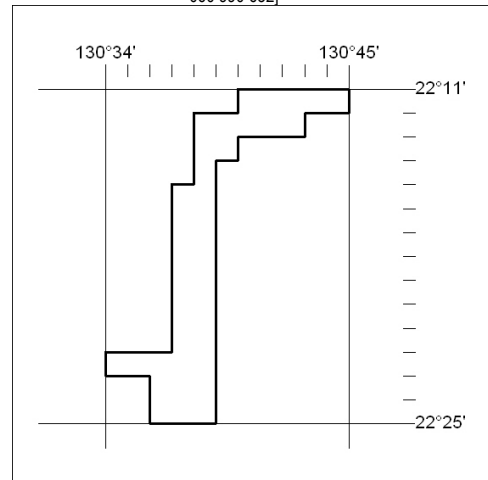

50/09



MN06/09

DARWIN

11 February 2009

Mining Act

NOTICE OF LAND CEASING TO BE AN EXPLORATION LICENCE AREA

Title Type and Number: Exploration Licence 25397
 Area Ceased on: 06 February 2009
 Area: 65 Blocks, 214.02 sq kms
 Locality: SELBY
 Name of Holder/s: 100% TERRITORY URANIUM COMPANY LTD* [ACN. 115 770 226]

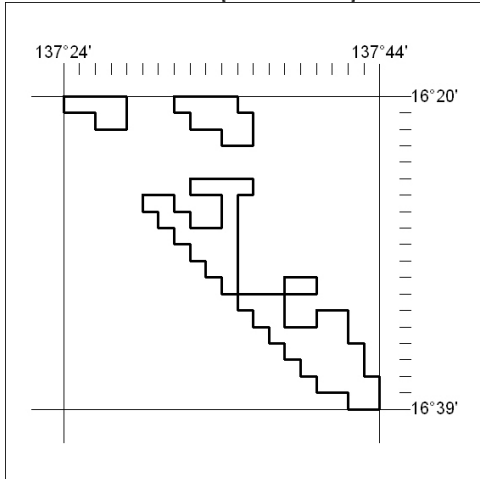

51/09

Mining Act

NOTICE OF LAND CEASING TO BE AN EXPLORATION LICENCE AREA

Title Type and Number: Exploration Licence 25633
 Area Ceased on: 06 January 2009
 Area: 3 Blocks, 2.14 sq kms
 Locality: RANFORD HILL
 Name of Holder/s: 100% SEGUE RESOURCES LIMITED [ACN. 112 609 846]

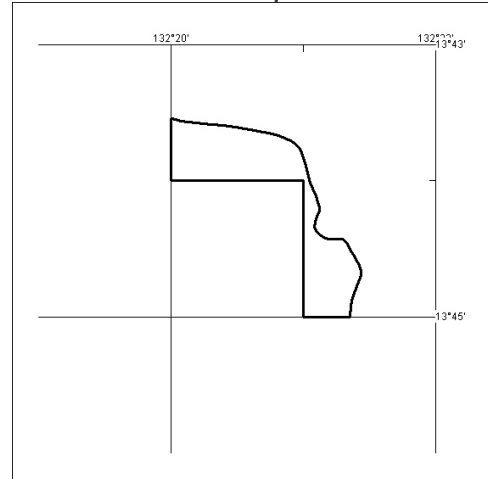

53/09

Mining Act

NOTICE OF LAND CEASING TO BE AN EXPLORATION LICENCE AREA

Title Type and Number: Exploration Licence 25531
 Area Ceased on: 06 January 2009
 Area: 7 Blocks, 14.06 sq kms
 Locality: RANFORD HILL
 Name of Holder/s: 100% SEGUE RESOURCES LIMITED [ACN. 112 609 846]

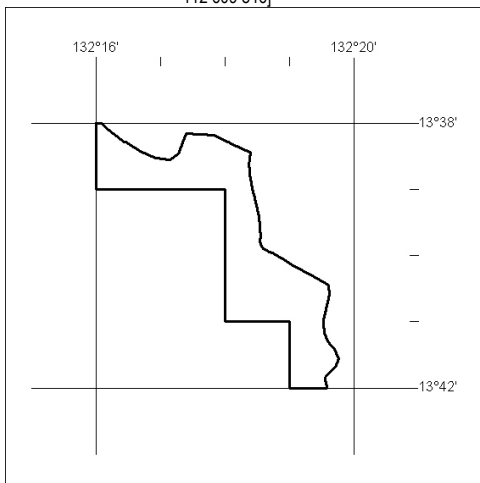

52/09

Mining Act

NOTICE OF GRANT OF AN EXPLORATION LICENCE

Title Type and Number: Exploration Licence 26705
 Granted: 04 February 2009, for a period of 6 Years
 Area: 20 Blocks, 64.68 sq kms
 Locality: KELLY
 Name of Holder/s: 100% MACKIE Alistair Wansbone

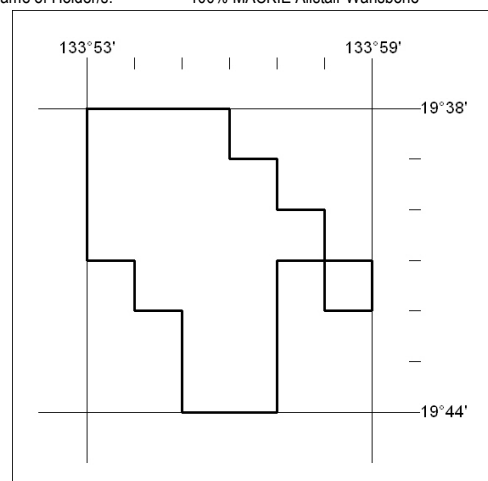

Area granted depicted above. Excluding therefrom all land that is subject of a mining tenement, or an application for a mining tenement made before the application for the grant of this licence, and excluding all land the subject of a reservation from occupation under the *Mining Act* and all land vested in the Commonwealth of Australia.

54/09



Mining Act

NOTICE OF GRANT OF AN EXPLORATION LICENCE

Title Type and Number: Exploration Licence 26706
 Granted: 04 February 2009, for a period of 6 Years
 Area: 11 Blocks, 35.51 sq kms
 Locality: TENNANT CREEK
 Name of Holder/s: 100% MACKIE Alistair Wansbone

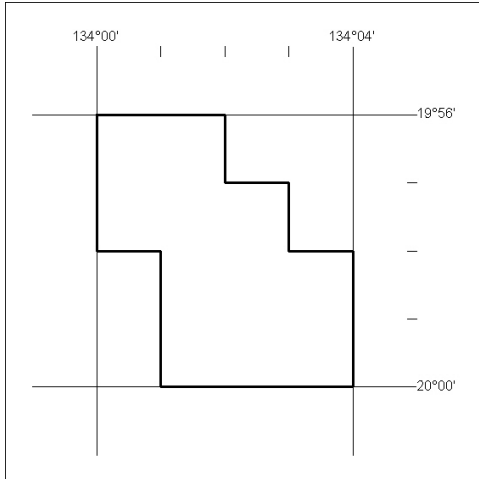

Area granted depicted above. Excluding therefrom all land that is subject of a mining tenement, or an application for a mining tenement made before the application for the grant of this licence, and excluding all land the subject of a reservation from occupation under the *Mining Act* and all land vested in the Commonwealth of Australia.

55/09

Mining Act

NOTICE OF GRANT OF AN EXPLORATION LICENCE

Title Type and Number: Exploration Licence 26818
 Granted: 06 February 2009, for a period of 6 Years
 Area: 432 Blocks, 1364.10 sq kms
 Locality: FAVENC
 Name of Holder/s: 100% NORTHERN URANIUM LIMITED [ACN. 119 966 353]

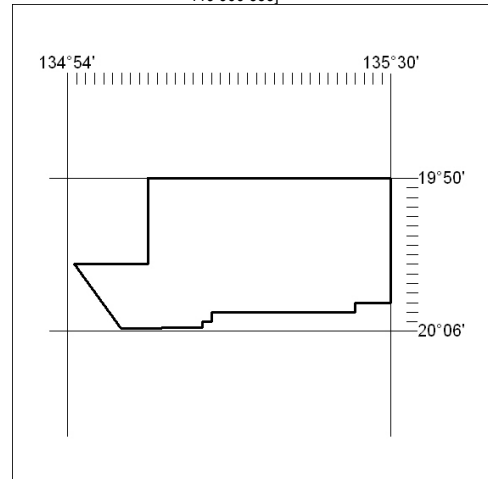

Area granted depicted above. Excluding therefrom all land that is subject of a mining tenement, or an application for a mining tenement made before the application for the grant of this licence, and excluding all land the subject of a reservation from occupation under the *Mining Act* and all land vested in the Commonwealth of Australia.

57/09

Mining Act

NOTICE OF GRANT OF AN EXPLORATION LICENCE

Title Type and Number: Exploration Licence 26775
 Granted: 06 February 2009, for a period of 6 Years
 Area: 500 Blocks, 1561.77 sq kms
 Locality: EPENARRA
 Name of Holder/s: 100% NORTHERN URANIUM LIMITED [ACN. 119 966 353]

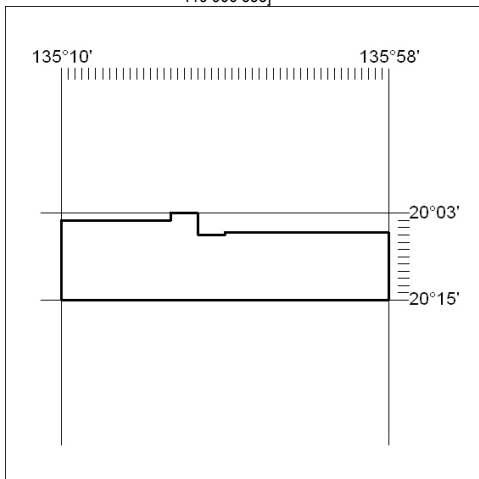

Area granted depicted above. Excluding therefrom all land that is subject of a mining tenement, or an application for a mining tenement made before the application for the grant of this licence, and excluding all land the subject of a reservation from occupation under the *Mining Act* and all land vested in the Commonwealth of Australia.

56/09