

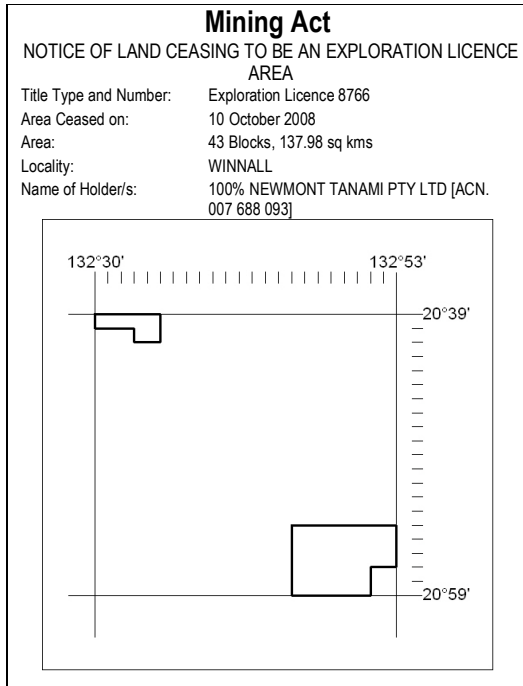

MN48/08

DARWIN

26 November 2008



594/08

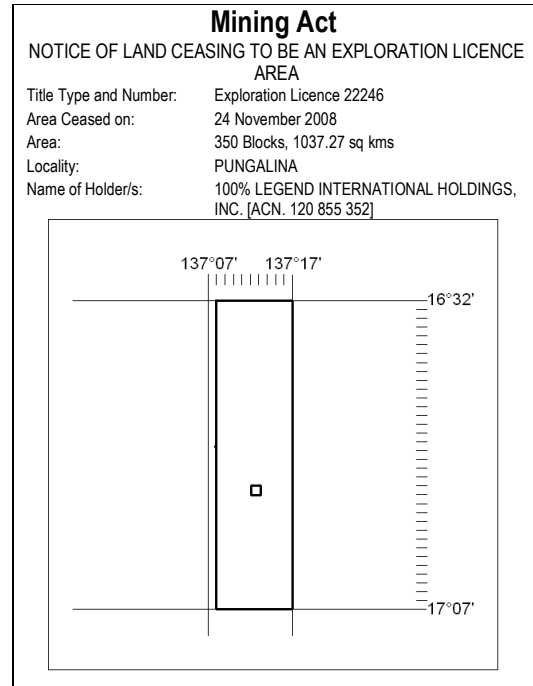

596/08

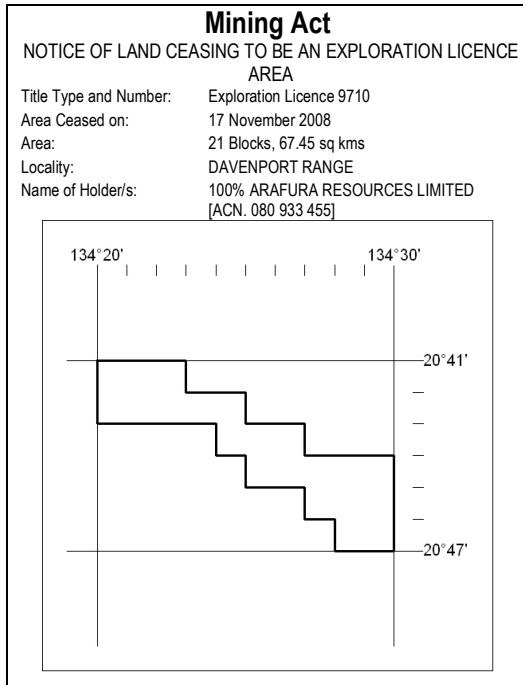

595/08

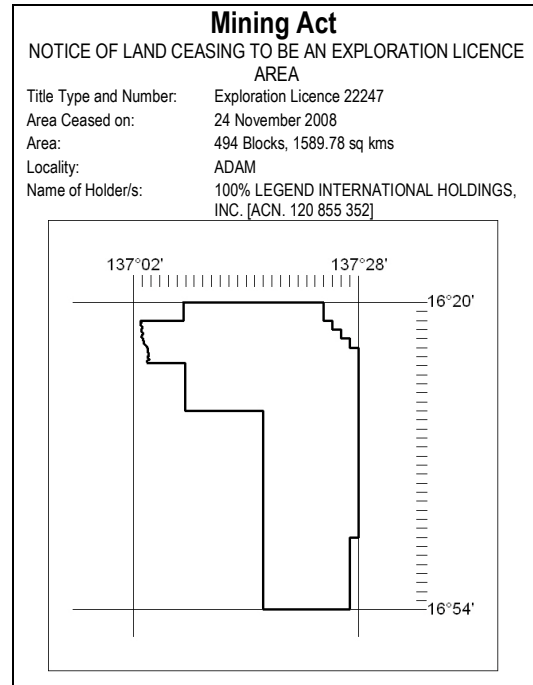

597/08



MN48/08

DARWIN

26 November 2008

Mining Act

NOTICE OF LAND CEASING TO BE AN EXPLORATION LICENCE AREA

Title Type and Number: Exploration Licence 22295
 Area Ceased on: 24 November 2008
 Area: 244 Blocks, 790.51 sq kms
 Locality: NUTWOOD
 Name of Holder/s: 100% LEGEND INTERNATIONAL HOLDINGS, INC. [ACN. 120 855 352]

598/08

Mining Act

NOTICE OF LAND CEASING TO BE AN EXPLORATION LICENCE AREA

Title Type and Number: Exploration Licence 23400
 Area Ceased on: 25 November 2008
 Area: 83 Blocks, 254.67 sq kms
 Locality: CONICAL HILL
 Name of Holder/s: 80% QUANTUM RESOURCES LIMITED [ACN. 006 690 348], 20% ASTRO DIAMOND MINES NL [ACN. 007 090 904]

600/08

Mining Act

NOTICE OF LAND CEASING TO BE AN EXPLORATION LICENCE AREA

Title Type and Number: Exploration Licence 22296
 Area Ceased on: 24 November 2008
 Area: 136 Blocks, 434.02 sq kms
 Locality: TANUMBIRINI
 Name of Holder/s: 100% LEGEND INTERNATIONAL HOLDINGS, INC. [ACN. 120 855 352]

599/08

Mining Act

NOTICE OF LAND CEASING TO BE AN EXPLORATION LICENCE AREA

Title Type and Number: Exploration Licence 23401
 Area Ceased on: 25 November 2008
 Area: 76 Blocks, 243.24 sq kms
 Locality: CRAWFORD
 Name of Holder/s: 80% QUANTUM RESOURCES LIMITED [ACN. 006 690 348], 20% ASTRO DIAMOND MINES NL [ACN. 007 090 904]

601/08



MN48/08

DARWIN

26 November 2008

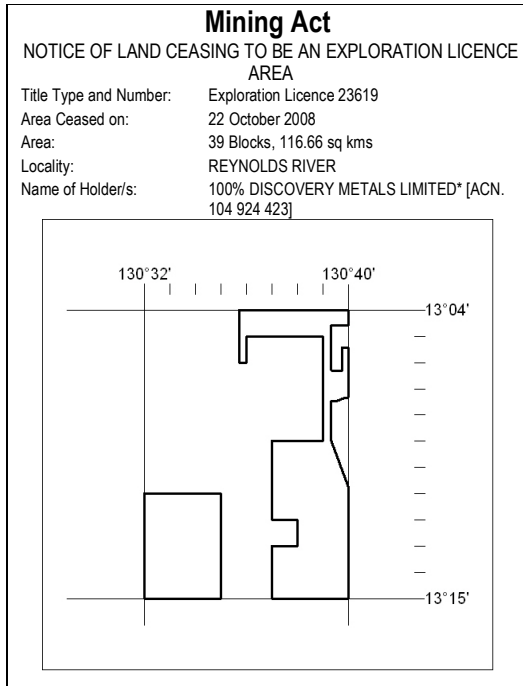

602/08

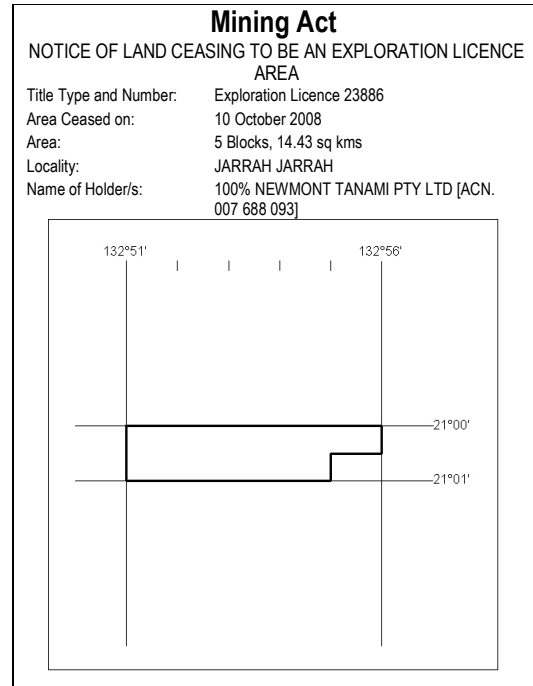

604/08

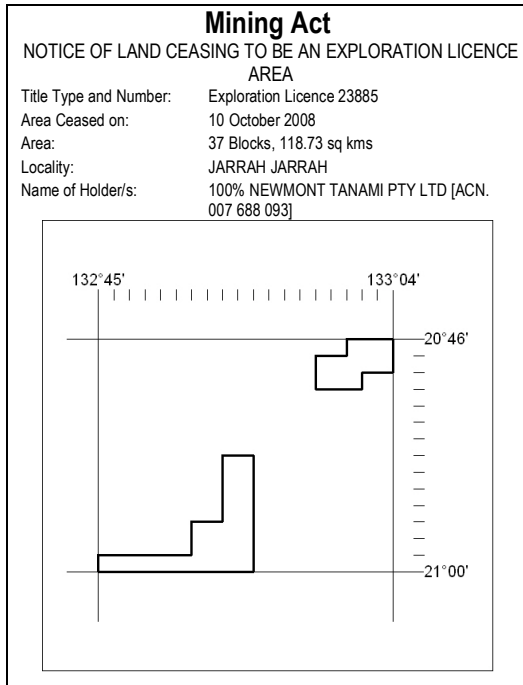

603/08

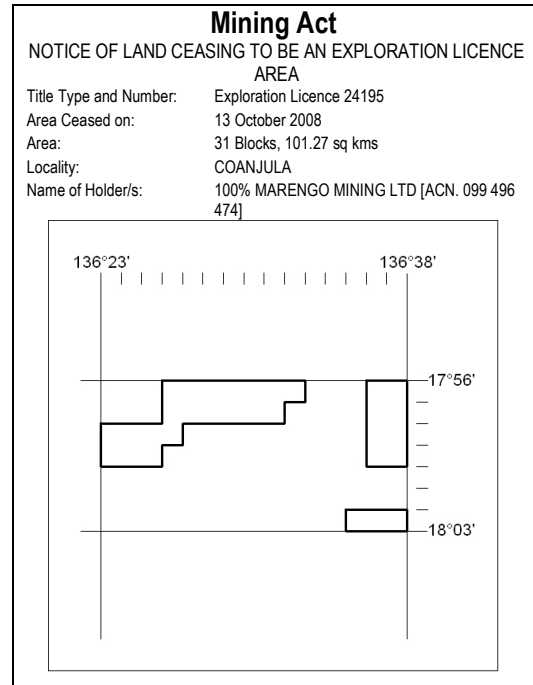

605/08



MN48/08

DARWIN

26 November 2008

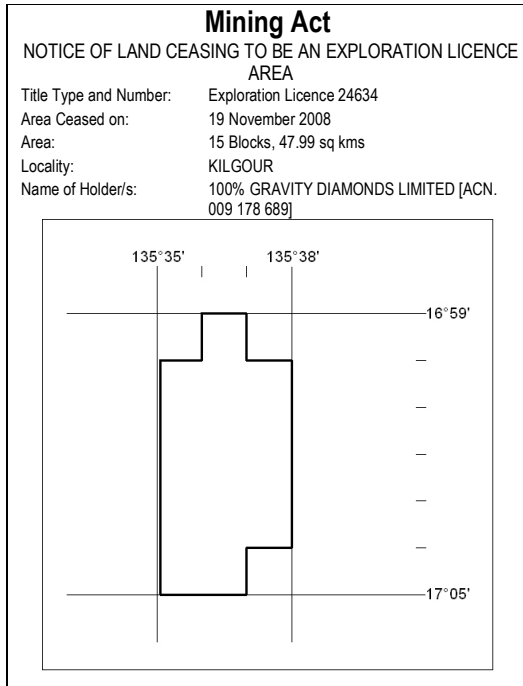

606/08

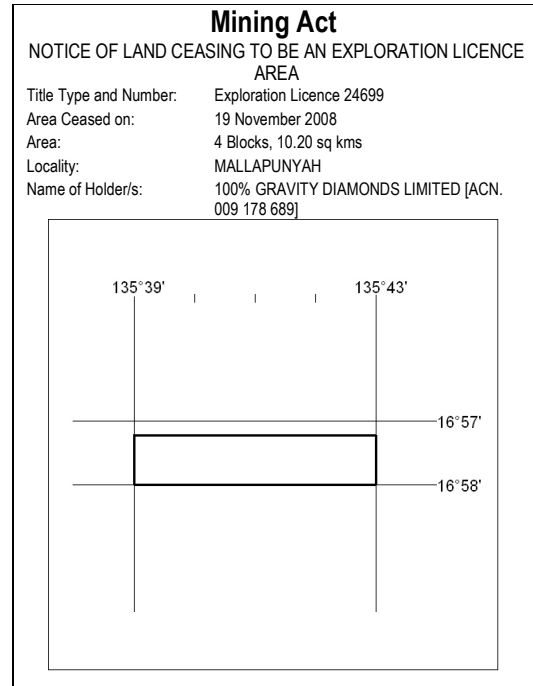

608/08

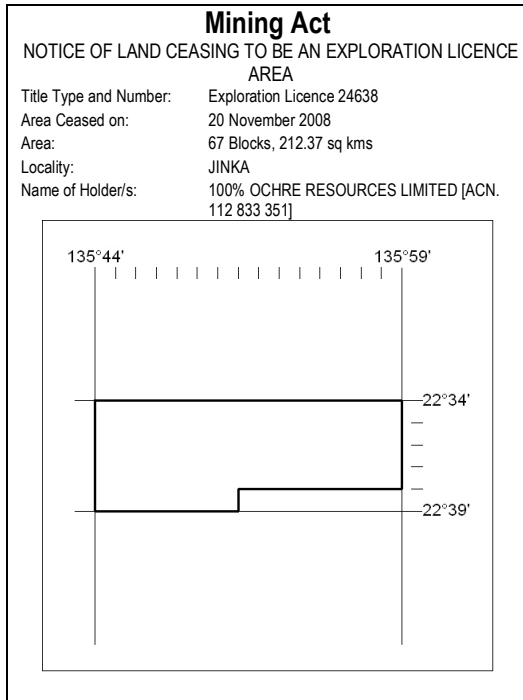

607/08

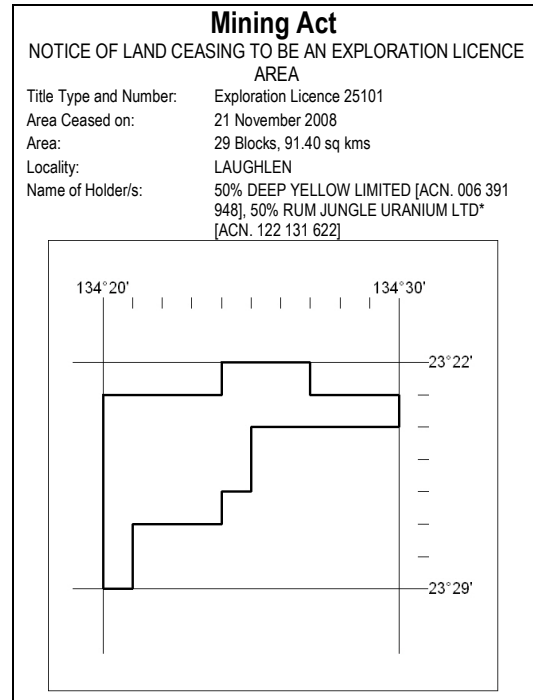

609/08



MN48/08

DARWIN

26 November 2008

Mining Act

NOTICE OF LAND CEASING TO BE AN EXPLORATION LICENCE AREA

Title Type and Number: Exploration Licence 25223
 Area Ceased on: 23 November 2008
 Area: 125 Blocks, 417.13 sq kms
 Locality: DALY RIVER
 Name of Holder/s: 100% TERRITORY URANIUM COMPANY LTD* [ACN. 115 770 226]

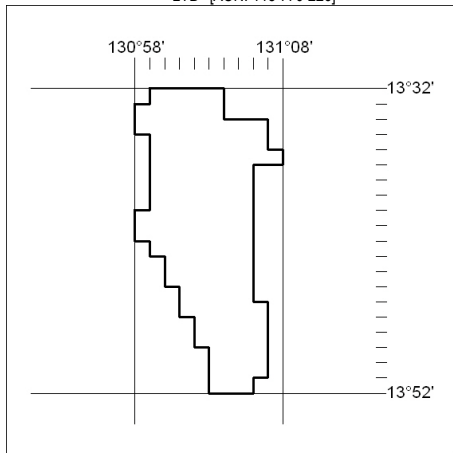

610/08

Mining Act

NOTICE OF LAND CEASING TO BE A MINING TENEMENT

Title Type and Number: Mineral Lease 23292
 Area ceased on: 14 November 2008
 Area: 1.25 Hectares
 Locality: BATCHELOR
 Name of Holder/s: 100% MAGNESIUM DEVELOPMENTS LTD [ACN. 083 764 827]

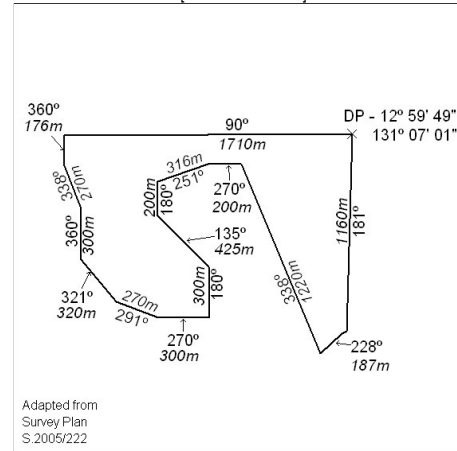

Adapted from
Survey Plan
S.2005/222

612/08

Mining Act

NOTICE OF LAND CEASING TO BE AN EXPLORATION LICENCE AREA

Title Type and Number: Exploration Licence 25350
 Area Ceased on: 11 September 2008
 Area: 34 Blocks, 68.24 sq kms
 Locality: TENNANT CREEK
 Name of Holder/s: 100% AGRICOLA RESOURCES PTY LTD [ACN. 111 720 597]

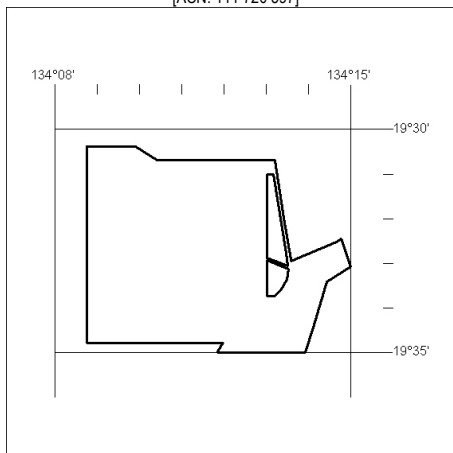

611/08

Mining Act

NOTICE OF GRANT OF AN EXPLORATION LICENCE

Title Type and Number: Exploration Licence 26697
 Granted: 21 November 2008, for a period of 6 Years
 Area: 16 Blocks, 51.02 sq kms
 Locality: BREADEN
 Name of Holder/s: 100% PALACE RESOURCES LIMITED [ACN. 106 240 475]

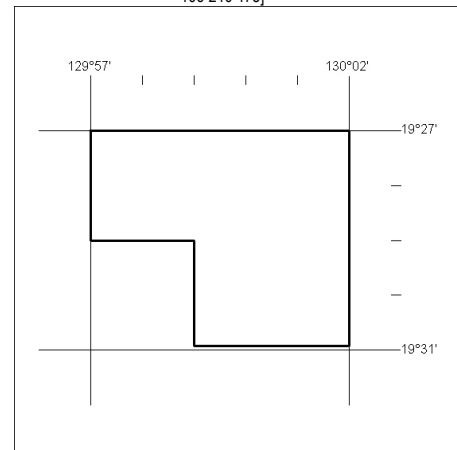

Area granted depicted above. Excluding therefrom all land that is subject of a mining tenement, or an application for a mining tenement made before the application for the grant of this licence, and excluding all land the subject of a reservation from occupation under the *Mining Act* and all land vested in the Commonwealth of Australia.

613/08



MN48/08

DARWIN

26 November 2008

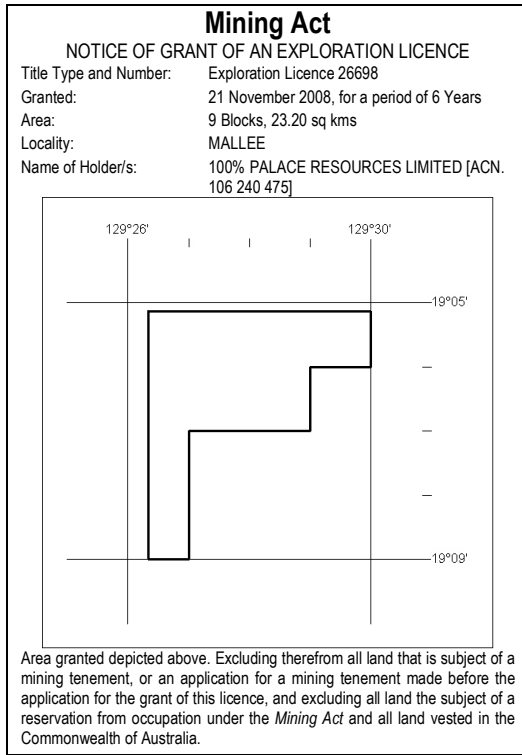

614/08

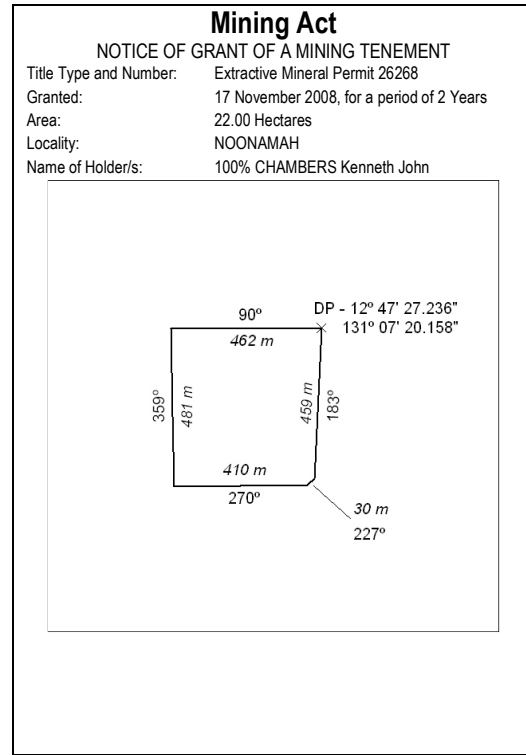

616/08

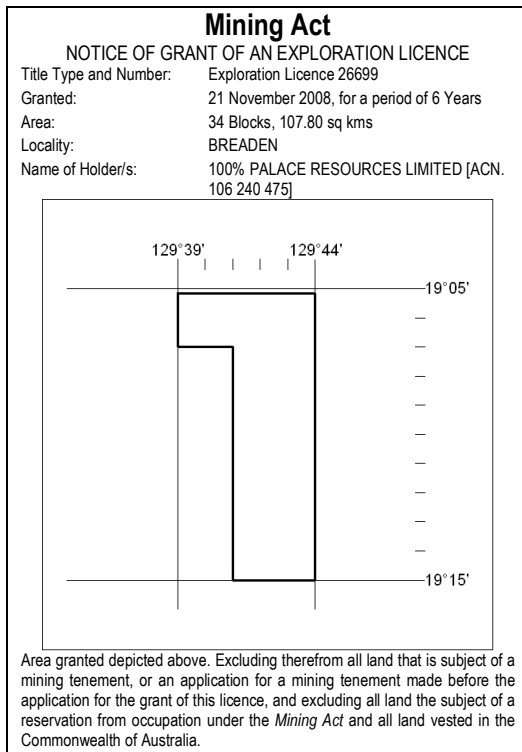

615/08

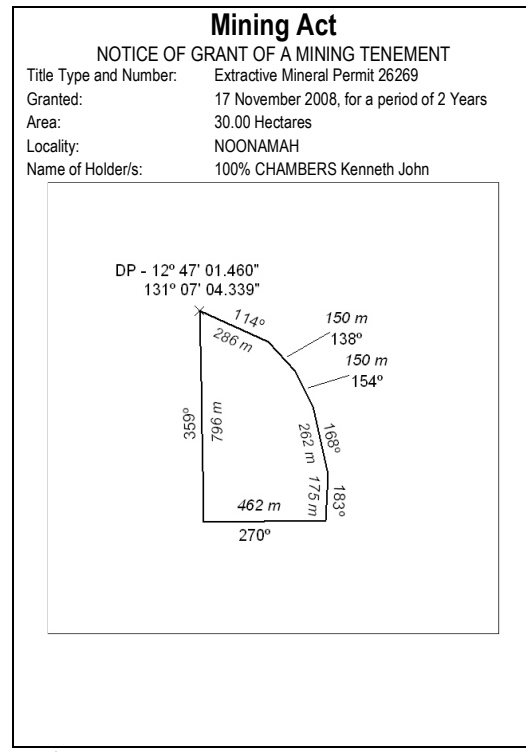

617/08



MN48/08

DARWIN

26 November 2008

Mining Act

NOTICE OF GRANT OF A MINING TENEMENT

Title Type and Number: Extractive Mineral Permit 26653
Granted: 21 November 2008, for a period of 2 Years
Area: 28.00 Hectares
Locality: NOONAMAH
Name of Holder/s: 100% A AND SF MADDALOZZO PTY. LIMITED [ACN. 009 624 015]

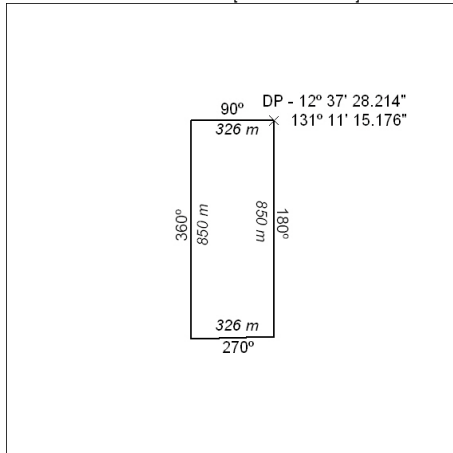

618/08

Mining Act

NOTICE OF GRANT OF A MINING TENEMENT

Title Type and Number: Extractive Mineral Permit 26721
Granted: 13 November 2008, for a period of 2 Years
Area: 9.00 Hectares
Locality: BURT
Name of Holder/s: 100% P.F. & C.J. BROWN PTY. LTD. [ACN. 009 652 868]

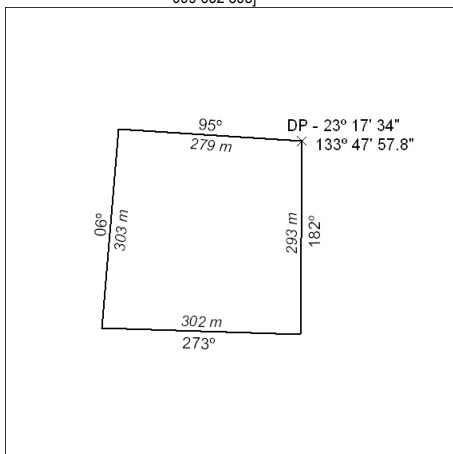

619/08